

REVISION	DESCRIPTION	CHECK	APP	DATE	REV. NOTICE. NO
△1					
△2					
△3					

QFN24-0.5转接板连线图

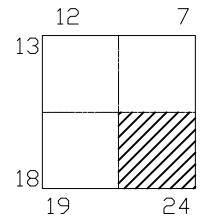

IC 脚位图

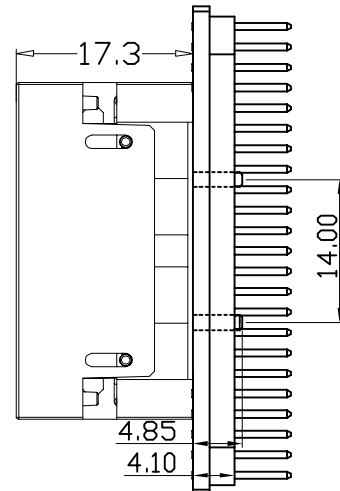
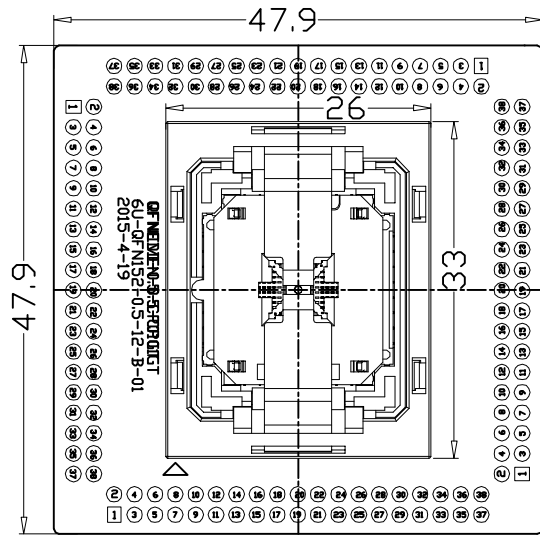
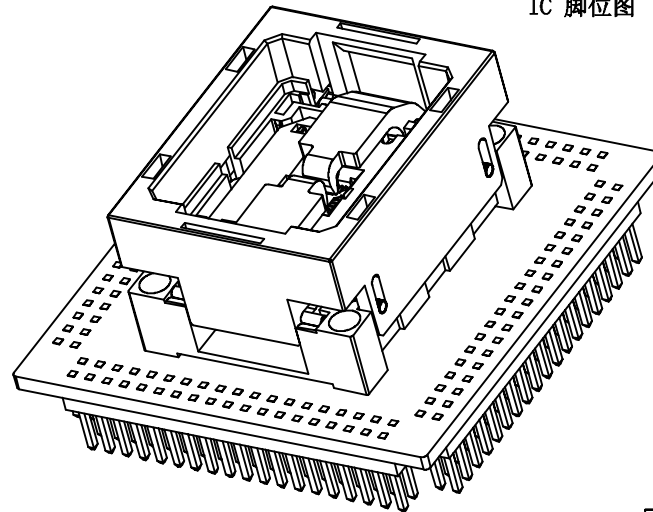
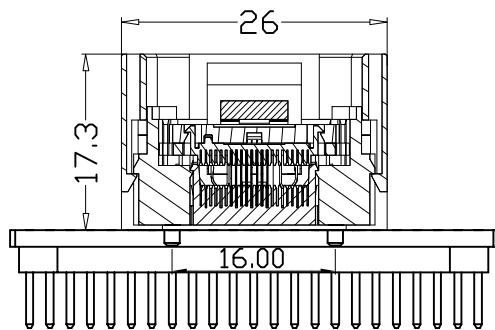
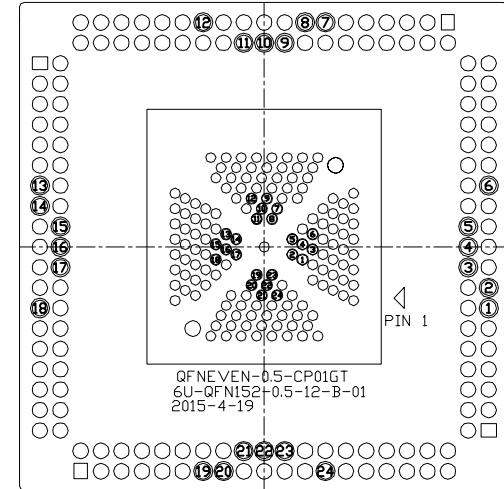

Applicable IC

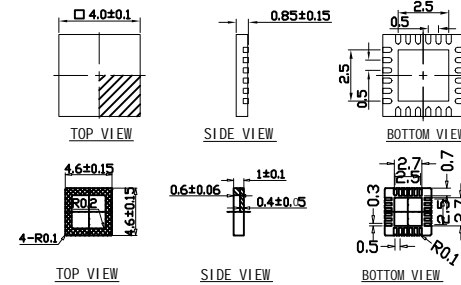

PROJECTION	GENERAL TOLERANCES	±0.10	TITLE	QFN24-0.5 SOCKET
	R E V	A	CLASS	QFN024-0.5-TP01G
DIMENSION:	mm	SCALE:	1: 1	DRW. NO QFN024-0.5-TP01G-A-01
APP:		DATE:		
CHECK:		DATE:		
DECK:		DATE: 20120822		